

[www.cela.it](http://www.cela.it)





22,00 m



14,00 m



260 kg



-2,00 m



230 kg

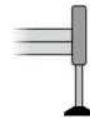

H+H



20,00 m

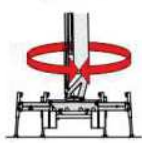

1440°



90°+90°

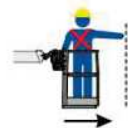

9,50 m



ALUMINIUM  
0,7X0,7X1,1  
1,4X0,7X1,1  
1,8X0,7X1,1



ELECTRONIC

# DT22

MIN. GWV 3,5 T

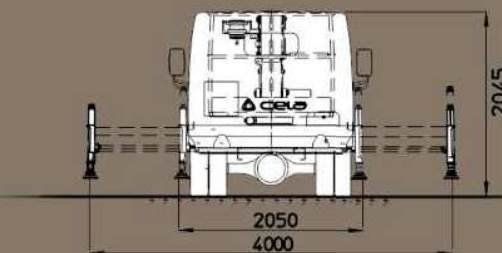
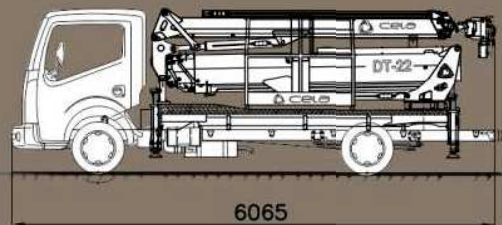
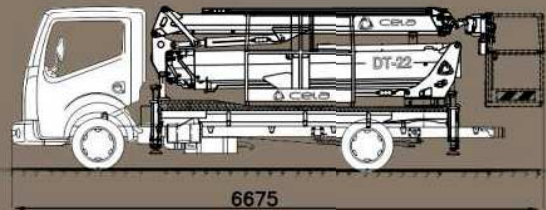
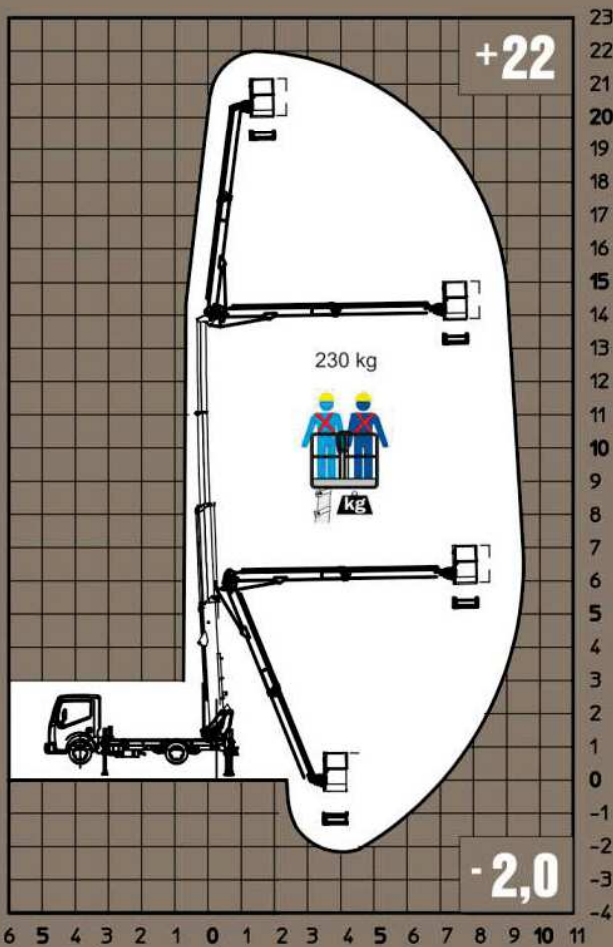

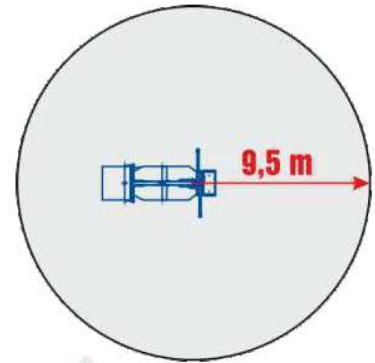
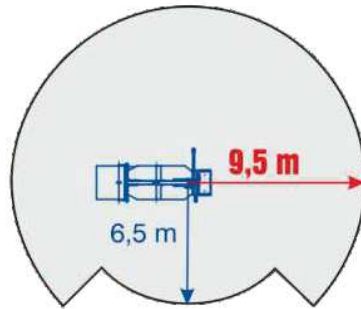
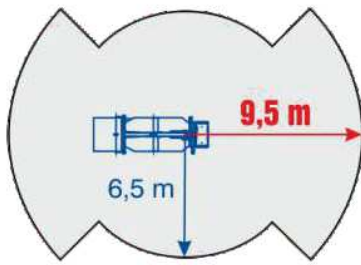

**CELA**  
industry

**La piattaforma invisibile**  
The invisible boom



**Passiamo sopra ogni cosa**  
We fly all over



**Sottosopra**  
Downunder



**Tutto in uno**  
All in one



**Atterriamo ovunque**  
We land everywhere

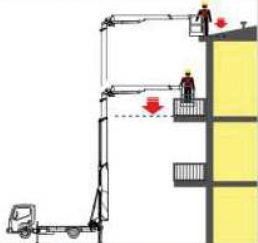

**Come un ascensore**  
Like an elevator

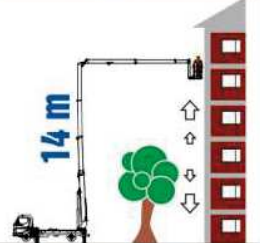

**Dolci e Veloci**  
Smooth and fast

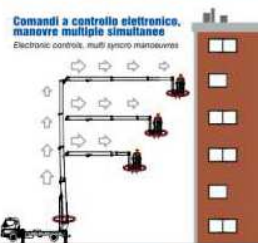

**Auto Stabilizzazione**  
Automatic Stabilization

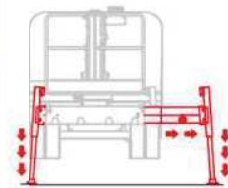

**Non ti facciamo girare la testa**  
We don't drive (your head) crazy



**Siamo i più forti**  
We are the strongest



**Sempre al tuo fianco**  
Always with you



**Ti spianiamo la strada**  
We pave your road

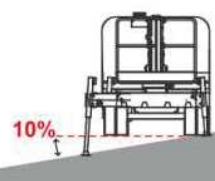

[www.cela.it](http://www.cela.it)

9,5 m

22,0 m

14,00

**DT22**